

6GHz RMS Power Detector with 40dB Dynamic Range

FEATURES

- Frequency Range: 10MHz to 6GHz
- Accurate Power Measurement of High Crest Factor (Up to 12dB) Waveforms
- 40dB Log Linear Dynamic Range
- Exceptional Accuracy Over Temperature
- Fast Response Time: 1 μ s Rise, 8 μ s Fall
- Low Power: 1.4mA at 3.3V
- Log-Linear DC Output vs Input RF Power in dBm
- Small 3mm \times 2mm 8-Pin DFN Package
- Single-Ended RF Input

APPLICATIONS

- GSM/EDGE, CMDA, CDMA2000, W-CDMA, LTE, WiMAX RF Power Control
- Pico-Cells, Femto-Cells RF Power Control
- Wireless Repeaters
- CATV/DVB Transmitters
- MIMO Wireless Access Points
- Portable RMS Power Measurement Instrumentation

DESCRIPTION

The LT[®]5581 is a 10MHz to 6GHz, low power monolithic precision RMS power detector. The RMS detector uses a proprietary technique to accurately measure the RF power from -34 dBm to $+6$ dBm (at 2.14GHz) of modulated signals with a crest factor as high as 12dB. It outputs a DC voltage in linear scale proportional to an RF input signal power in dBm. The LT5581 is suitable for precision power measurement and control for a wide variety of RF standards, including GSM/EDGE, CDMA, CDMA2000, W-CDMA, TD-SCDMA, UMTS, LTE and WiMAX, etc. The final DC output is connected in series with an on-chip 300 Ω resistor, which enables further filtering of the output modulation ripple with just a single off-chip capacitor.

LT, LT, LTC and LTM are registered trademarks of Linear Technology Corporation. All other trademarks are the property of their respective owners. Protected by U.S. Patents, including 7342431.

TYPICAL APPLICATION

10MHz to 6GHz Infrastructure Power Amplifier Level Control

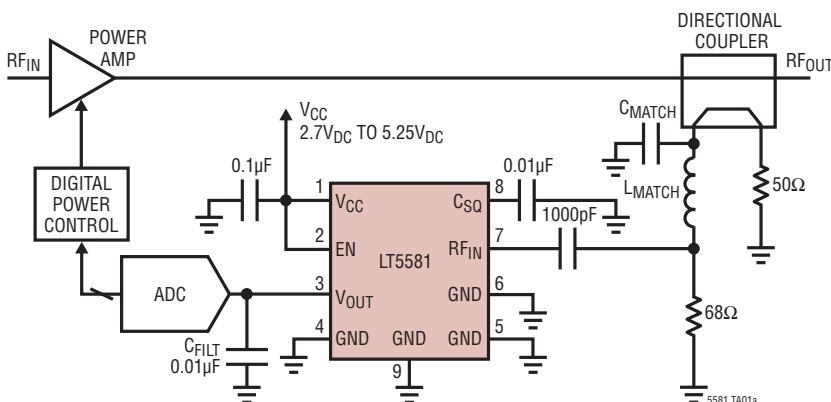

Linearity Error vs RF Input Power, 2140MHz Modulated Waveforms

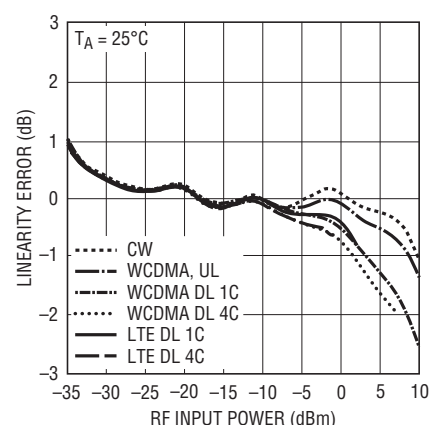

5581 TA01b

LT5581

ABSOLUTE MAXIMUM RATINGS

(Note 1)

Supply Voltage	5.5V
Maximum Input Signal Power—Average	15dBm
Maximum Input Signal Power—Peak (Note 7)	25dBm
DC Voltage at RF _{IN}	-0.3V to 2V
V _{OUT} Voltage	-0.3V to V _{CC} + 0.3V
Maximum Junction Temperature, T _{JMAX}	150°C
Operating Temperature Range	-40°C to 85°C
Storage Temperature Range	-65°C to 150°C

CAUTION: This part is sensitive to electrostatic discharge. It is very important that proper ESD precautions be observed when handling the LT5581.

PIN CONFIGURATION

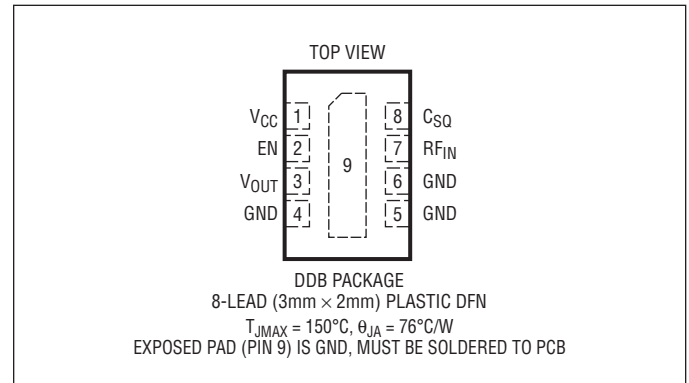

ORDER INFORMATION

LEAD FREE FINISH	TAPE AND REEL	PART MARKING	PACKAGE DESCRIPTION	TEMPERATURE RANGE
LT5581IDDB#PBF	LT5581IDDB#TRPBF	LDKM	8-Lead (3mm × 2mm) Plastic DFN	-40°C to 85°C

Consult LTC Marketing for parts specified with wider operating temperature ranges.

Consult LTC Marketing for information on non-standard lead based finish parts.

For more information on lead free part marking, go to: <http://www.linear.com/leadfree/>

For more information on tape and reel specifications, go to: <http://www.linear.com/tapeandreeel/>

ELECTRICAL CHARACTERISTICS The ● denotes the specifications which apply over the full operating temperature range, otherwise specifications are at T_A = 25°C, V_{CC} = 3.3V, EN = 3.3V, unless otherwise noted (Note 2). Test circuit is shown in Figure 1.

PARAMETER	CONDITIONS	MIN	TYP	MAX	UNITS
AC Input					
Input Frequency Range (Note 4)			10-6000		MHz
Input Impedance			205 1.6		Ω pF
f_{RF} = 450MHz					
RF Input Power Range	Externally Matched to 50Ω Source		-34 to 6		dBm
Linear Dynamic Range, CW (Note 3)	±1dB Linearity Error		40		dB
Linear Dynamic Range, CDMA (Note 3)	±1dB Linearity Error; CDMA 4-Carrier		40		dB
Output Slope			31		mV/dB
Logarithmic Intercept (Note 5)			-42		dBm
Output Variation vs Temperature	Normalized to Output at 25°C, -40°C < T _A < 85°C; P _{IN} = -34 to +6dBm		±1		dB
Output Variation vs Temperature	Normalized to Output at 25°C, -40°C < T _A < 85°C; P _{IN} = -27 to -10dBm		±0.5		dB
Deviation from CW Response; P _{IN} = -34dBm to 0dBm	TETRA π/4 DQPSK CDMA 4-Carrier 64-Channel Fwd 1.23Mcps		±0.1 ±0.5		dB dB

5581f

ELECTRICAL CHARACTERISTICS The ● denotes the specifications which apply over the full operating temperature range, otherwise specifications are at $T_A = 25^\circ\text{C}$, $V_{CC} = 3.3\text{V}$, $V_{EN} = 3.3\text{V}$, unless otherwise noted (Note 2). Test circuit is shown in Figure 1.

PARAMETER	CONDITIONS	MIN	TYP	MAX	UNITS
2nd Order Harmonic Distortion	At RF Input; CW Input; $P_{IN} = 0\text{dBm}$		-57		dBc
3rd Order Harmonic Distortion	At RF Input; CW Input; $P_{IN} = 0\text{dBm}$		-52		dBc
$f_{RF} = 880\text{MHz}$					
RF Input Power Range	Externally Matched to 50Ω Source		-34 to 6		dBm
Linear Dynamic Range, CW (Note 3)	$\pm 1\text{dB}$ Linearity Error		40		dB
Linear Dynamic Range, EDGE (Note 3)	$\pm 1\text{dB}$ Linearity Error; EDGE $3\pi/8$ -Shifted 8PSK		40		dB
Output Slope			31		mV/dB
Logarithmic Intercept (Note 5)			-42		dBm
Output Variation vs Temperature	Normalized to Output at 25°C , $-40^\circ\text{C} < T_A < 85^\circ\text{C}$; $P_{IN} = -34$ to $+6\text{dBm}$		± 1		dB
Output Variation vs Temperature	Normalized to Output at 25°C , $-40^\circ\text{C} < T_A < 85^\circ\text{C}$; $P_{IN} = -27$ to -10dBm		± 0.5		dB
Deviation from CW Response, $P_{in} = -34$ to $+6\text{dBm}$	EDGE $3\pi/8$ Shifted 8PSK		± 0.1		dB
$f_{RF} = 2140\text{MHz}$					
RF Input Power Range	Externally Matched to 50Ω Source		-34 to 6		dBm
Linear Dynamic Range, CW (Note 3)	$\pm 1\text{dB}$ Linearity Error		43		dB
Linear Dynamic Range, WCDMA (Note 3)	$\pm 1\text{dB}$ Linearity Error; 4-Carrier WCDMA		37		dB
Output Slope			31		mV/dB
Logarithmic Intercept (Note 5)			-42		dBm
Output Variation vs Temperature	Normalized to Output at 25°C , $-40^\circ\text{C} < T_A < 85^\circ\text{C}$; $P_{IN} = -34$ to 6dBm		± 1		dB
Output Variation vs Temperature	Normalized to Output at 25°C , $-40^\circ\text{C} < T_A < 85^\circ\text{C}$; $P_{IN} = -27$ to -10dBm		± 0.5		dB
Maximum Deviation from CW Response $P_{IN} = -34$ to -4dBm	WCDMA 1-Carrier Uplink WCDMA 64-Channel 4-Carrier Downlink		± 0.1 ± 0.5		dB dB
$f_{RF} = 2600\text{MHz}$					
RF Input Power Range	Externally Matched to 50Ω Source		-34 to 6		dBm
Linear Dynamic Range, CW (Note 3)	$\pm 1\text{dB}$ Linearity Error		40		dB
Output Slope			31		mV/dB
Logarithmic Intercept (Note 5)			-42		dBm
Output Variation vs Temperature	Normalized to Output at 25°C , $-40^\circ\text{C} < T_A < 85^\circ\text{C}$; $P_{IN} = -34$ to $+6\text{dBm}$		± 1		dB
Output Variation vs Temperature	Normalized to Output at 25°C , $-40^\circ\text{C} < T_A < 85^\circ\text{C}$; $P_{IN} = -27$ to -10dBm		± 0.5		dB
Maximum Deviation from CW Response $P_{IN} = -34$ to 2dBm	WiMAX OFDMA Preamble WiMAX OFDM Burst		± 0.1 ± 0.5		dB dB
$f_{RF} = 3500\text{MHz}$					
RF Input Power Range	Externally Matched to 50Ω Source		-30 to 6		dBm
Linear Dynamic Range, CW (Note 3)	$\pm 1\text{dB}$ Linearity Error		36		dB
Output Slope			31		mV/dB
Logarithmic Intercept (Note 5)			-41		dBm
Output Variation vs Temperature	Normalized to Output at 25°C , $-40^\circ\text{C} < T_A < 85^\circ\text{C}$; $P_{IN} = -30$ to $+6\text{dBm}$		± 1		dB

ELECTRICAL CHARACTERISTICS The ● denotes the specifications which apply over the full operating temperature range, otherwise specifications are at $T_A = 25^\circ\text{C}$, $V_{CC} = 3.3\text{V}$, $EN = 3.3\text{V}$, unless otherwise noted (Note 2). Test circuit is shown in Figure 1.

PARAMETER	CONDITIONS	MIN	TYP	MAX	UNITS	
Output Variation vs Temperature	Normalized to Output at 25°C , $-40^\circ\text{C} < T_A < 85^\circ\text{C}$; $P_{IN} = -27$ to -10dBm		± 0.5		dB	
Deviation from CW Response $P_{IN} = -34$ to -4dBm	WiMAX OFDMA Preamble WiMAX OFDM Burst		± 0.1 ± 0.5		dB dB	
$f_{RF} = 5800\text{MHz}$						
RF Input Power Range	Externally Matched to 50Ω Source		-25 to 6		dBm	
Linear Dynamic Range, CW (Note 3)	$\pm 1\text{dB}$ Linearity Error		31		dB	
Output Slope			31		mV/dB	
Logarithmic Intercept (Note 5)			-33		dBm	
Output Variation vs Temperature	Normalized to Output at 25°C , $-40^\circ\text{C} < T_A < 85^\circ\text{C}$; $P_{IN} = -25$ to $+6\text{dBm}$		± 1		dB	
Output Variation vs Temperature	Normalized to Output at 25°C , $-40^\circ\text{C} < T_A < 85^\circ\text{C}$; $P_{IN} = -20$ to $+6\text{dBm}$		± 0.5		dB	
Deviation from CW Response	WiMAX OFDM Burst; $P_{IN} = -25$ to 6dBm		± 0.2		dB	
Output						
Output DC Voltage	No Signal Applied to RF Input		180		mV	
Output Impedance	Internal Series Resistor Allows for Off-Chip Filter Cap		300		Ω	
Output Current Sourcing/Sinking			$5/5$		mA	
Rise Time	0.2V to 1.6V , 10% to 90% , $f_{RF} = 2140\text{MHz}$		1		μs	
Fall Time	1.6V to 0.2V , 10% to 90% , $f_{RF} = 2140\text{MHz}$		8		μs	
Power Supply Rejection Ratio (Note 6)	For Over Operating Input Power Range		49		dB	
Integrated Output Voltage Noise	1kHz to 6.5kHz Integration BW, $P_{IN} = 0\text{dBm}$ CW		150		μV_{RMS}	
Enable (EN) Low = Off, High = On						
EN Input High Voltage (On)		●	2		V	
EN Input Low Voltage (Off)		●		0.3	V	
Enable Pin Input Current	$EN = 3.3\text{V}$		20		μA	
Turn-On Time; CW RF input	V_{OUT} Within 10% of Final Value; $P_{IN} = 0\text{dBm}$		1		μs	
Settling Time; RF Pulse	V_{OUT} Within 10% of Final Value; $P_{IN} = 0\text{dBm}$		1		μs	
Power Supply						
Supply Voltage		●	2.7	3.3	5.25	V
Supply Current	No RF Input Signal			1.4		mA
Shutdown Current	$EN = 0.3\text{V}$, $V_{CC} = 3.3\text{V}$			0.2	6	μA

Note 1: Stresses beyond those listed under Absolute Maximum Ratings may cause permanent damage to the device. Exposure to any Absolute Maximum Rating condition for extended periods may affect device reliability and lifetime.

Note 2: The LT5581 is guaranteed to meet specified performance from -40°C to 85°C .

Note 3: The linearity error is calculated by the difference between the incremental slope of the output and the average output slope from -20dBm to 0dBm . The dynamic range is defined as the range over which the linearity error is within $\pm 1\text{dB}$.

Note 4: An external capacitor at the C_{SQ} pin should be used for input frequencies below 250MHz . Lower frequency operation results in excessive RF ripple in the output voltage.

Note 5: Logarithmic intercept is an extrapolated input power level from the best fitted log-linear straight line, where the output voltage is 0V .

Note 6: PSRR is determined as the dB value of the change in V_{OUT} voltage over the change in V_{CC} supply voltage.

Note 7: Not production tested. Guaranteed by design and correlation to production tested parameters.

TYPICAL PERFORMANCE CHARACTERISTICS

Performance characteristics taken at $V_{CC} = 3.3V$, $EN = 3.3V$ and $T_A = 25^\circ C$, unless otherwise noted. (Test circuit shown in Figure 1)

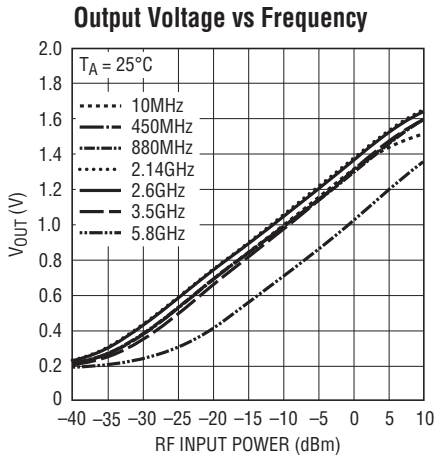

5581 G01

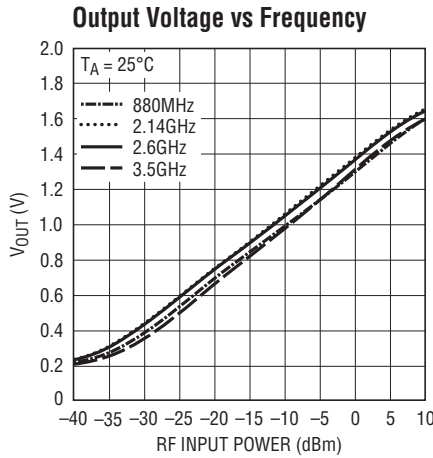

5581 G02

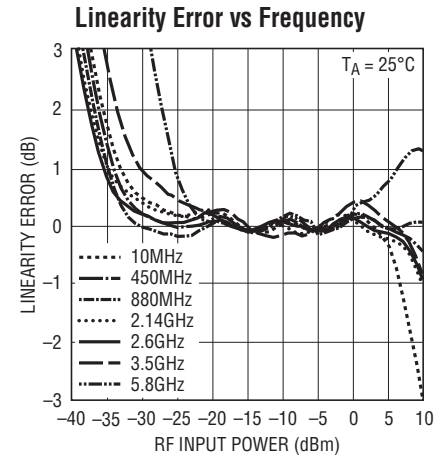

5581 G03

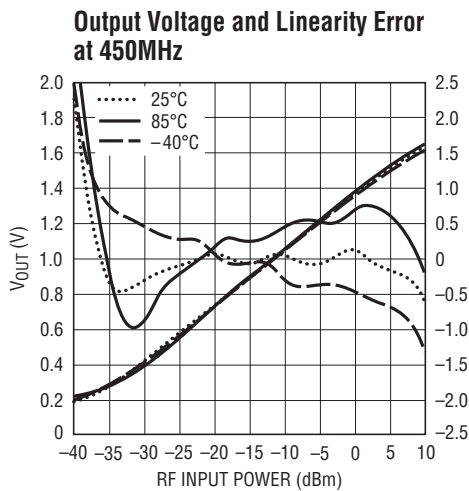

5581 G04

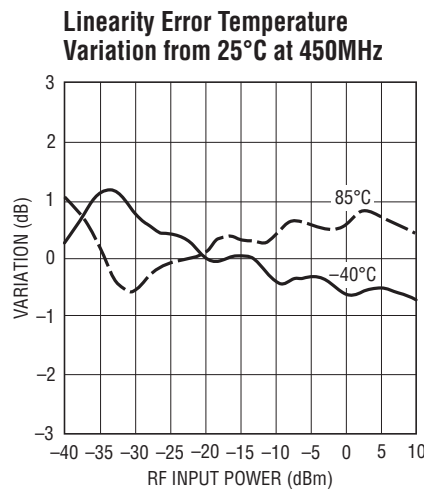

5581 G05

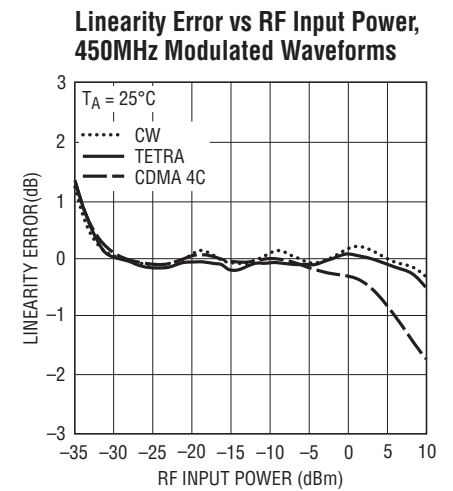

5581 G06

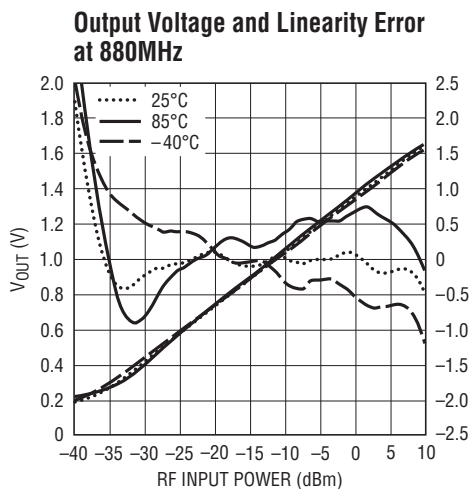

5581 G07

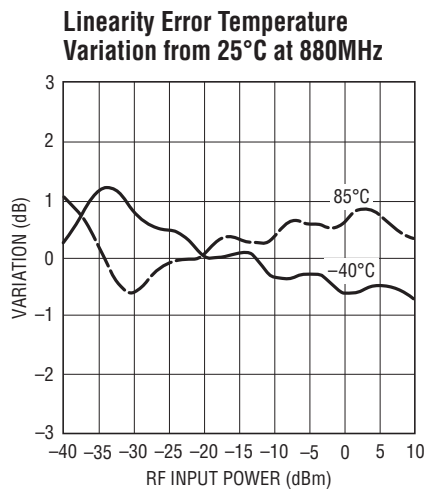

5581 G08

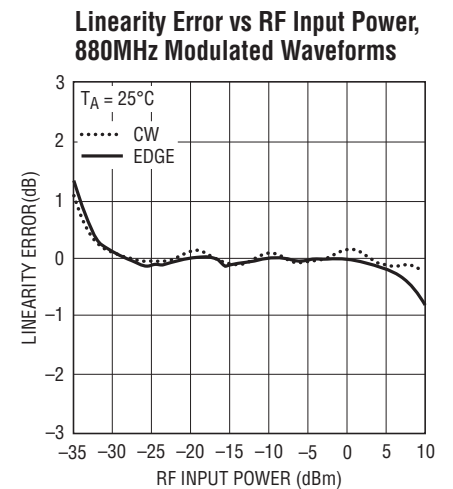

5581 G09

TYPICAL PERFORMANCE CHARACTERISTICS

Output Voltage and Linearity Error at 2140MHz

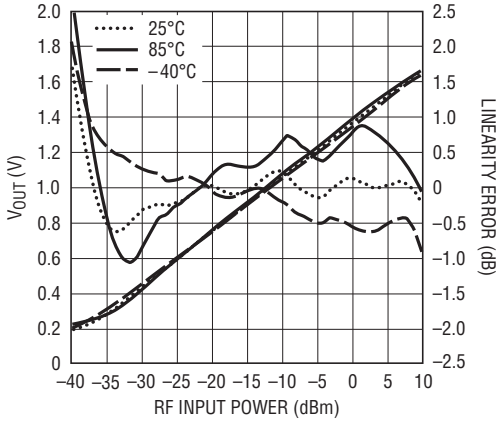

5581 G10

Linearity Error Temperature Variation from 25°C at 2140MHz

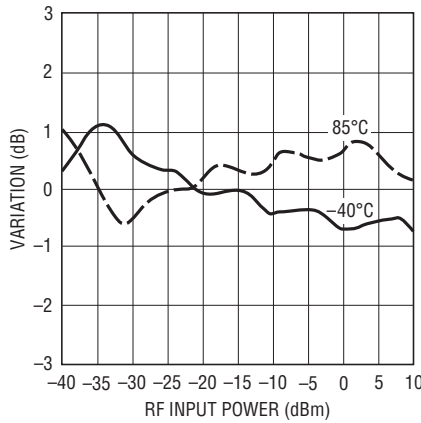

5581 G11

Linearity Error vs RF Input Power, 2140MHz Modulated Waveforms

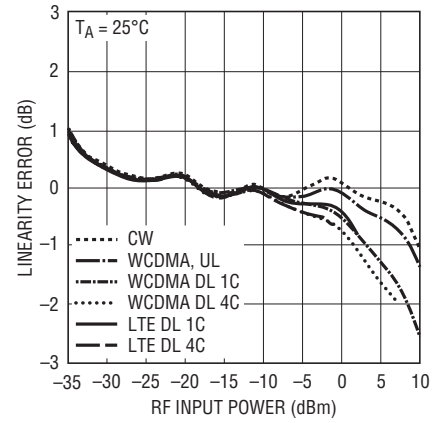

5581 G12

Output Voltage and Linearity Error at 2600MHz

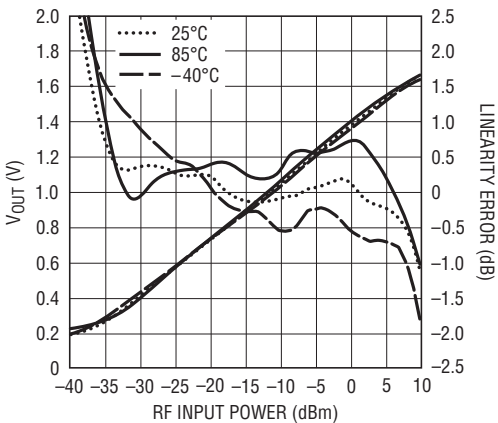

5581 G13

Linearity Error Temperature Variation from 25°C at 2600MHz

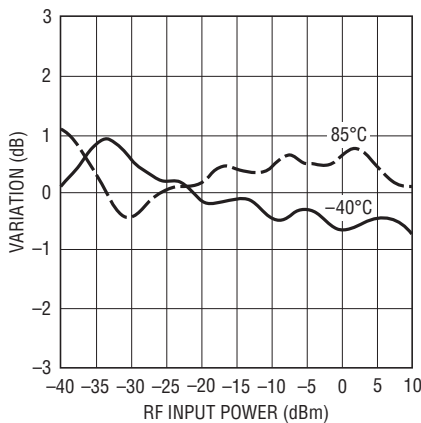

5581 G14

Linearity Error vs RF Input Power, 2.6GHz Modulated Waveforms

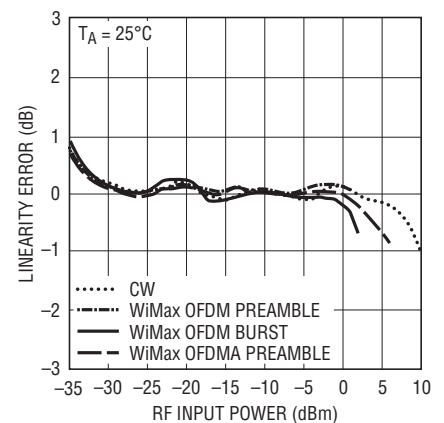

5581 G15

Output Voltage and Linearity Error at 3500MHz

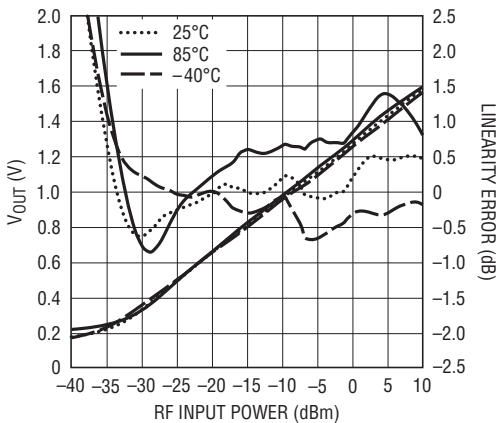

5581 G16

Linearity Error Temperature Variation from 25°C at 3500MHz

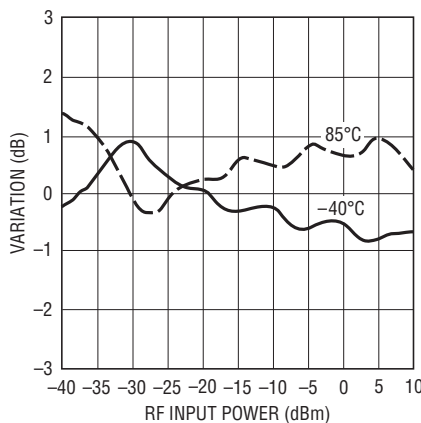

5581 G17

Linearity Error vs RF Input Power, 3.5GHz Modulated Waveforms

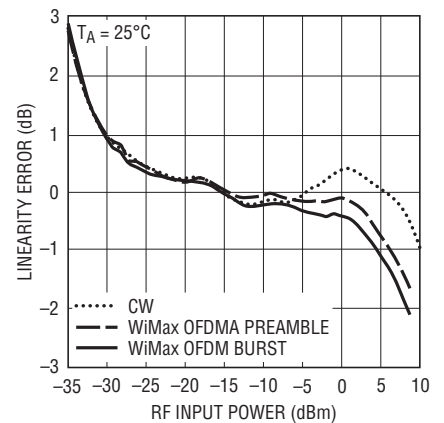

5581 G18

TYPICAL PERFORMANCE CHARACTERISTICS

Output Voltage and Linearity Error at 5800MHz

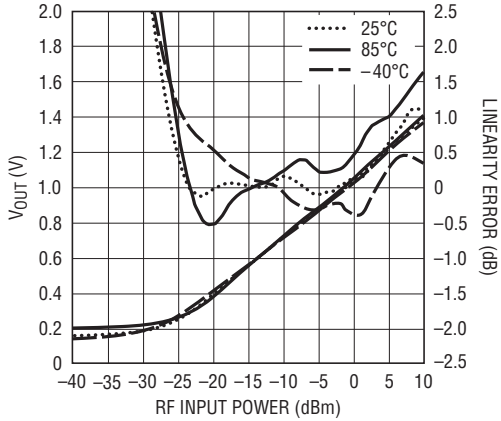

5581 G19

Linearity Error Temperature Variation from 25°C at 5800MHz

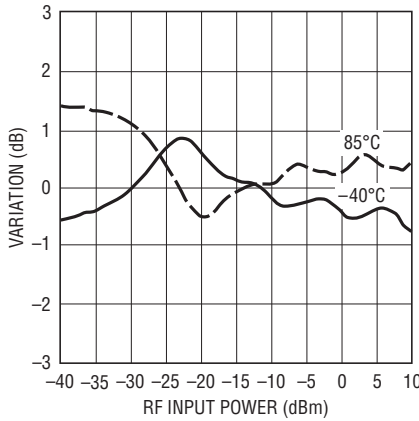

5581 G20

Linearity Error vs RF Input Power, 5.8GHz Modulated Waveforms

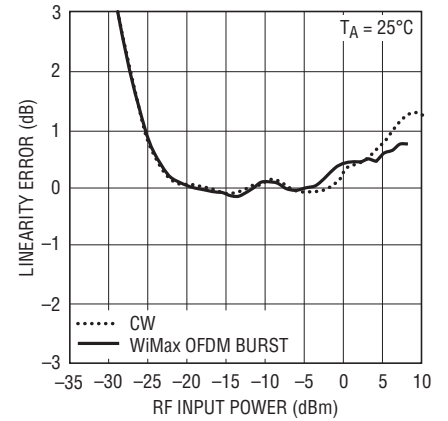

5581 G21

Slope vs Frequency

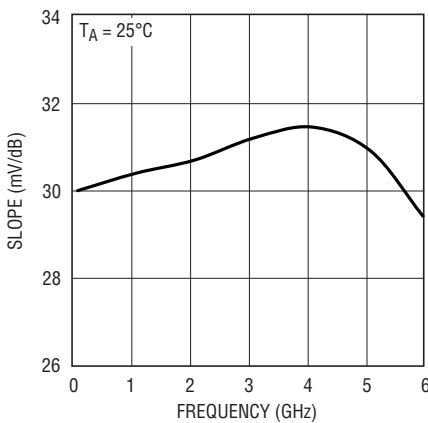

5581 G22

Slope Distribution vs Temperature

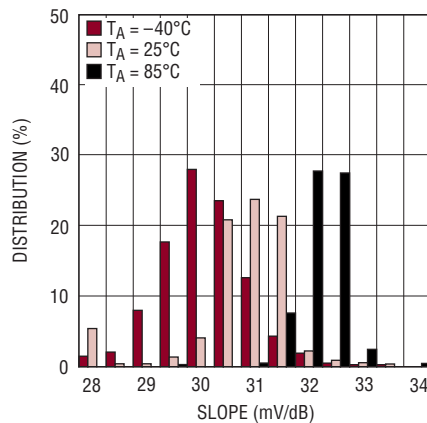

5581 G23

Supply Current vs Supply Voltage

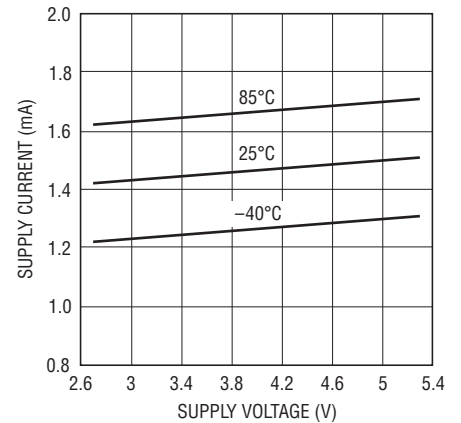

5581 G24

Logarithmic Intercept vs Frequency

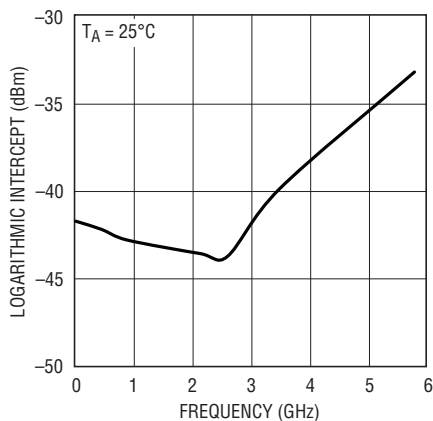

5581 G25

Logarithmic Intercept Distribution vs Temperature

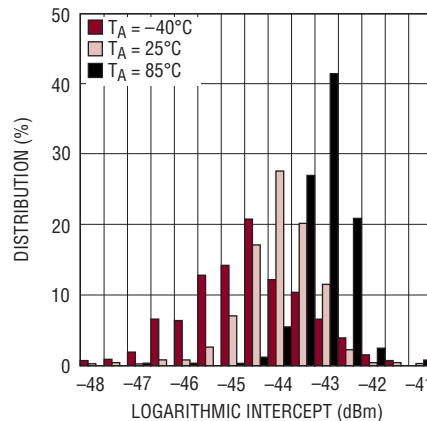

5581 G26

TYPICAL PERFORMANCE CHARACTERISTICS

Supply Current vs RF Input Power

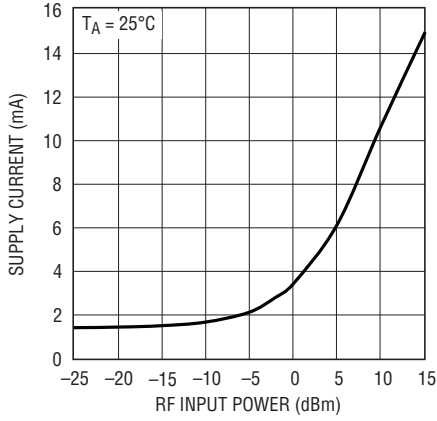

5581 G27

Output Voltage and Linearity Error vs V_{CC} at 2140MHz

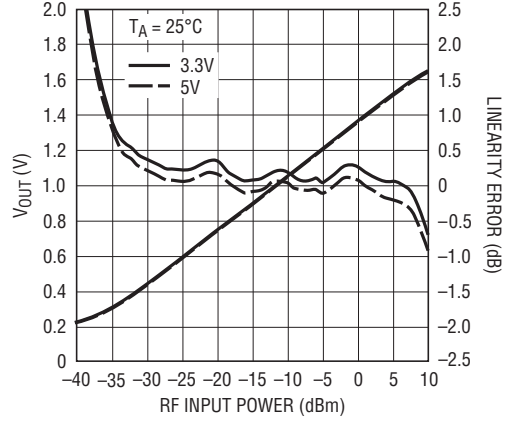

5581 G28

Return Loss vs Frequency Reference in Figure 1 Test Circuit

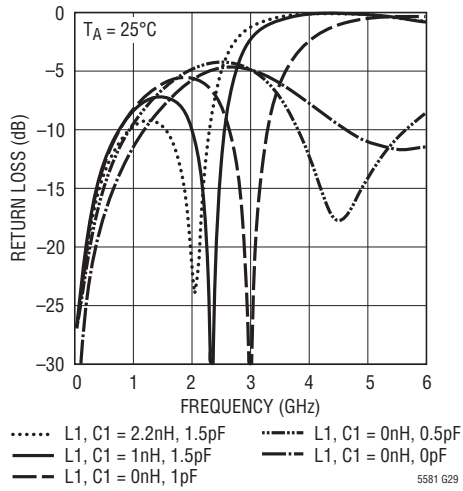

5581 G29

Output Transient Response with RF and EN Pulse

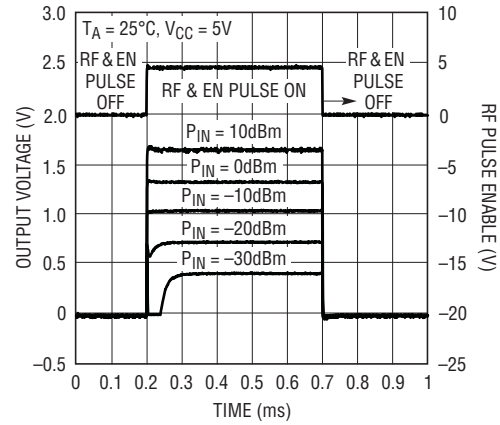

5581 G30

Output Transient Response

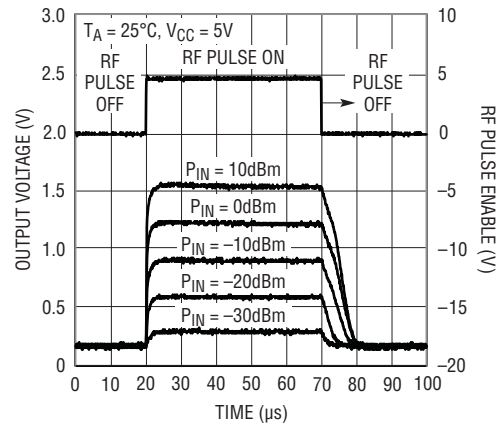

5581 G31

Output Transient Response with CW RF and EN Pulse

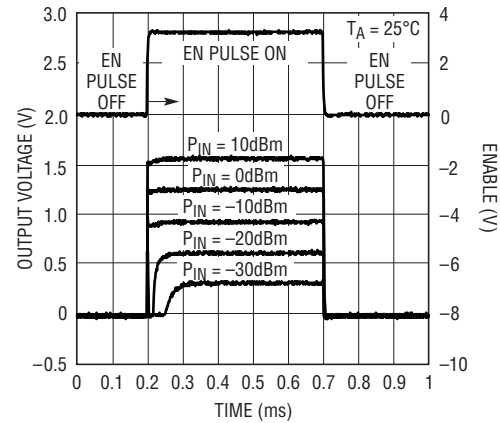

5581 G32

PIN FUNCTIONS

V_{CC} (Pin 1): Power Supply, 2.7V to 5.25V. V_{CC} should be bypassed with a 0.1μF ceramic capacitor.

EN (Pin 2): Chip Enable. A logic low or no-connect on the enable pin shuts down the part. A logic high enables the part. An internal 500k pull-down resistor ensures the part is off when the enable driver is in a three-state condition.

V_{OUT} (Pin 3): Detector Output.

GND (Pins 4, 5, 6): Ground.

RF_{IN} (Pin 7): RF Input. Should be DC-blocked with coupling capacitor; 1000pF recommended. This pin has an internal 200Ω termination.

C_{SQ} (Pin 8): Optional Low Frequency Range Extension Capacitor. This pin is for frequencies below 250MHz. Use 0.01μF from pin to ground for 10MHz operation.

Exposed Pad (Pin 9): Ground. The Exposed Pad must be soldered to the PCB. For high frequency operation, the backside ground connection should have a low inductance connection to the PCB ground, using many through-hole vias. See the layout information in the Applications Information section.

BLOCK DIAGRAM

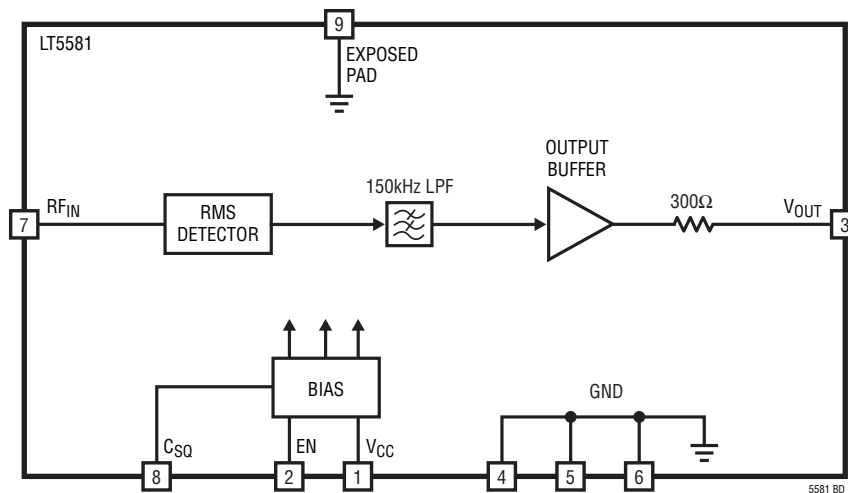

TEST CIRCUIT

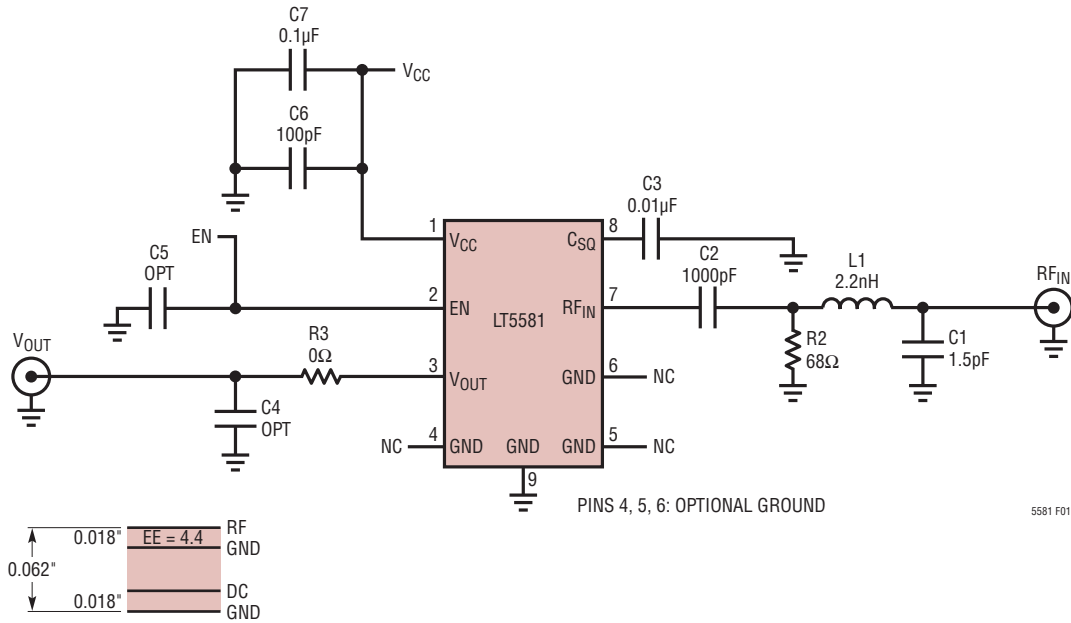

REF DES	VALUE	SIZE	PART NUMBER
C6	100pF	0603	AVX 06033A101KAT2A
C7	0.1µF	0603	AVX 06033C104KAT2A
C3	0.01µF	0603	AVX 06033C103KAT2A
C2	1000pF	0603	AVX 06033C102KAT2A
R2	68Ω	0603	

FREQUENCY RANGE	RF _{IN} MATCH	
	L1	C1
1GHz to 2.2GHz	2.2nH	1.5pF
2GHz to 2.6GHz	1.2nH	1.5pF
2.6GHz to 3.4GHz	0	1pF
3.8GHz to 5.5GHz	0	0.5pF
4.6GHz to 6GHz	0	0

Figure 1. Evaluation Circuit Schematic

APPLICATIONS INFORMATION

OPERATION

To achieve an accurate average power measurement of the high crest factor modulated RF signals, the LT5581 combines a proprietary high speed power measurement subsystem with an internal 150kHz low pass averaging filter and an output voltage buffer in a completely integrated solution with minimal off-chip components. The resulting output voltage is directly proportional to the average RF input power in dBm. Figure 1 shows the evaluation circuit schematic, and Figures 2 and 3 show the associated board artwork. For best high frequency performance, it is important to place many ground vias directly under the package.

RF Input Matching

The input resistance is about 205Ω. Input capacitance is 1.6pF. The impedance vs frequency of the RF input is detailed in Table 1.

Table 1. RF Input Impedance

FREQUENCY (MHz)	INPUT IMPEDANCE (Ω)	S11	
		MAG	ANGLE (°)
10	203.6-j5.5	0.606	-0.8
50	199.5-j22.4	0.603	-3.4
100	191.7-j40.3	0.601	-6.4
200	171.1-j68.5	0.601	-12.3
400	121.8-j95.4	0.608	-24
500	100.2-j97.5	0.613	-29.8
800	56.8-j86.5	0.631	-46.5
900	48-j81.2	0.638	-51.8
1000	41.1-j76	0.645	-56.8
1500	22.2-j55	0.679	-79.5
2000	14.6-j41.4	0.710	-97.9
2100	13.6-j39.2	0.716	-101.2
2500	10.8-j32.1	0.737	-112.9
3000	8.6-j25	0.759	-125.7
3500	7.3-j19.4	0.774	-136.9
4000	6.6-j14.5	0.783	-147.1
5000	8.8-j9.6	0.709	-157.6
6000	6.4-j0	0.774	-179.9

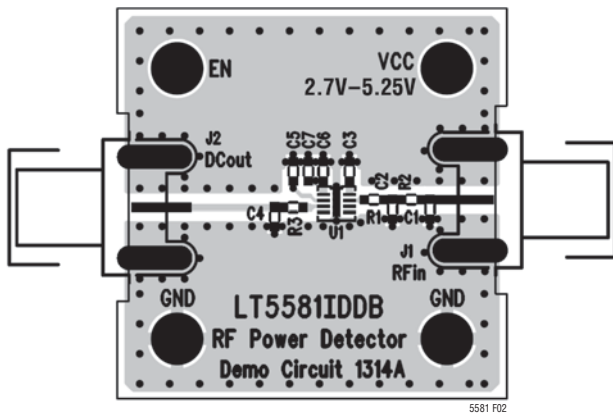

Figure 2. Top Side of Evaluation Board

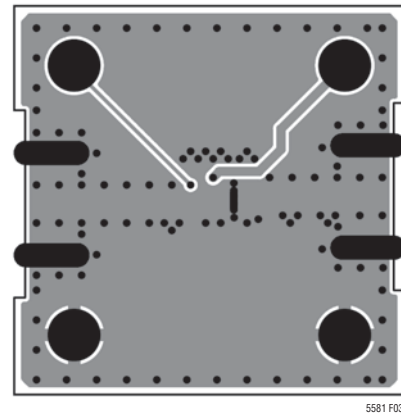

Figure 3. Bottom Side of Evaluation Board

APPLICATIONS INFORMATION

A shunt 68Ω resistor can be used to provide a broadband impedance match at low frequencies up to 1.3GHz, and from 4.5GHz to 6GHz. As shown in Figure 4, a nominal broadband input match can be achieved up to 2.2GHz by using an LC matching circuit consisting of a series 2.2nH inductor (L1) and a shunt 1.5pF capacitor (C1). This match will maintain a return loss of about 10dB across the band. For matching at higher frequencies, values for L1 and C1 are listed in the table of Figure 1. The input reflection coefficient referenced to the RF input pin (with no external components) is shown on the Smith Chart in Figure 5. Alternatively, it is possible to match using an impedance transformation network by omitting R1 and transforming the 205Ω load to 50Ω . The resulting match, over a narrow band of frequencies, will improve sensitivity up to about 6dB maximum; the dynamic range remains the same. For example, by omitting R1 and setting $L1 = 1.8\text{nH}$ and $C1 = 3\text{pF}$, a 2:1 VSWR match can be obtained from 1.95GHz to 2.36GHz, with a sensitivity improvement of 5dB.

The RF_{IN} input DC blocking capacitor (C2) and the C_{SQ} bias decoupling capacitor (C3), can be adjusted for low

frequency operation. For input frequencies down to 10MHz, $0.01\mu\text{F}$ is needed at C_{SQ} . For frequencies above 250MHz, the on-chip 20pF decoupling capacitor is sufficient, and C_{SQ} may be eliminated as desired. The DC-blocking capacitor can be as large as 2200pF for 10MHz operation, or 100pF for 2GHz operation. A DC-blocking capacitor larger than 2200pF results in an undesirable RF pulse response on the falling edge. Therefore, for general applications, the recommended value for C2, is conservatively set at 1000pF.

Output Interface

The output buffer of the LT5581 is shown in Figure 6. It includes a push-pull stage with a series 300Ω resistor. The output stage is capable of sourcing and sinking 5mA of current. The output pin can be shorted to GND or V_{CC} without damage, but going beyond $V_{\text{CC}} + 0.5\text{V}$ or $\text{GND} - 0.5\text{V}$ may result in damage, as the internal ESD protection diodes will start to conduct excessive current.

The residual ripple, due to RF modulation, can be reduced by adding external components R_{SS} and C_{LOAD} (R3 and C4 on the Evaluation Circuit Schematic in Figure 1) to

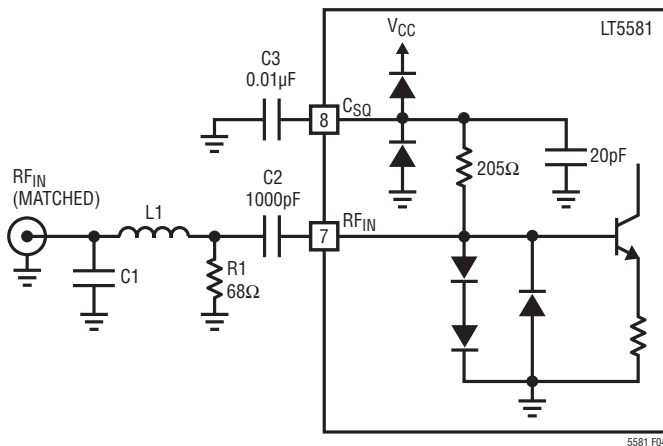

Figure 4. Simplified Circuit Schematic of the RF Input Interface

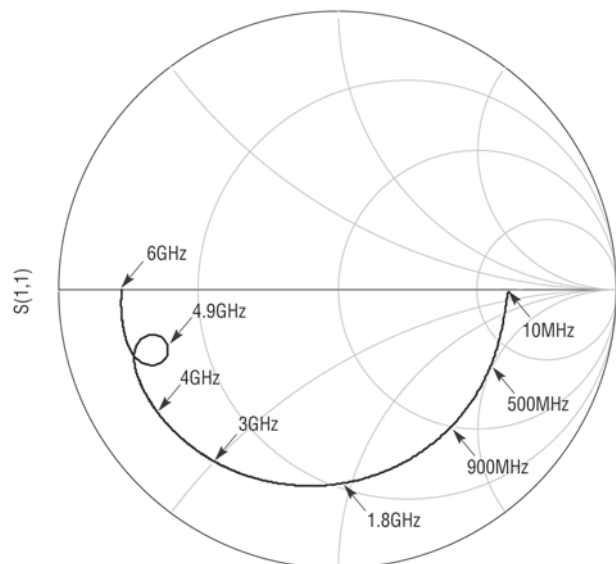

Figure 5. Input Reflection Coefficient

APPLICATIONS INFORMATION

the output pin, to form an RC lowpass filter. The internal 300Ω resistor in series with the output pin enables filtering of the output signal with just the addition of C_{LOAD}. Figure 7 shows the effect of the external filter capacitor on the residual ripple level for a 4-carrier WCDMA signal at 2.14GHz with -10dBm. Adding a 10nF capacitor to the output decreases the peak-to-peak output ripple from 135mV_{P-P} to 50mV_{P-P}. The filter -3dB corner frequency can be calculated with the following equation:

$$f_c = \frac{1}{2\pi C_{LOAD}(300 + R_{SS})}$$

Figure 8 shows the transient response for a 2.6GHz WiMAX signal, with preamble and burst ripple reduced by a factor

of 3, using a 0.047μF external filter capacitor. The average power in the preamble section is -10dBm, while the burst section has a 3dB lower average power. With the capacitor, the ripple in the preamble section is about 0.5dB. The modulation used was OFDM (WiMAX 802.16-2004) MMDS band, 1.5MHz BW, with 256 size FFT and 1 burst at QPSK 3/4.

Figure 9 shows how the peak-to-peak ripple decreases with increasing external filter capacitance value. Also shown is how the RF pulse response will have longer rise and fall times with the addition of this lowpass filter cap.

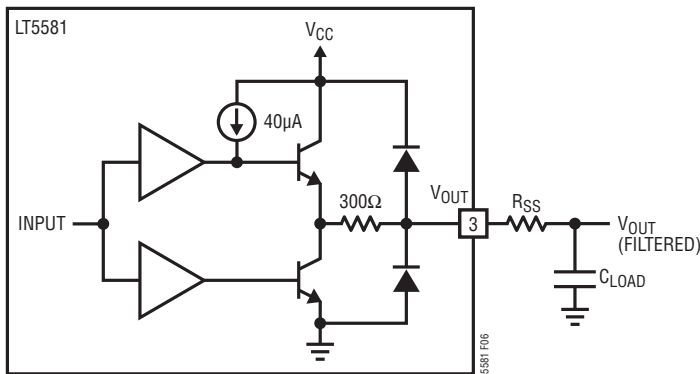

Figure 6. Simplified Circuit Schematic of the Output Interface

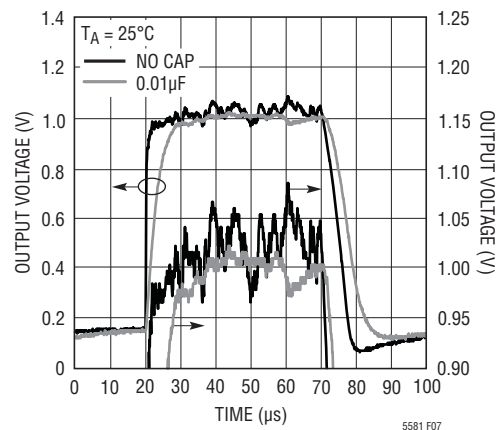

Figure 7. Residual Ripple, Output Transient Response for RF Pulse with WCDMA 4-Carrier Modulation

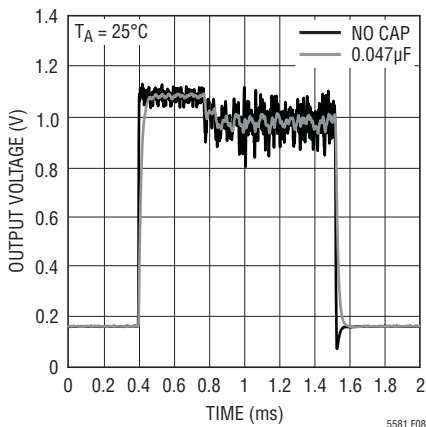

Figure 8. Residual Ripple for 2.6GHz WiMAX OFDM 802.16-2004

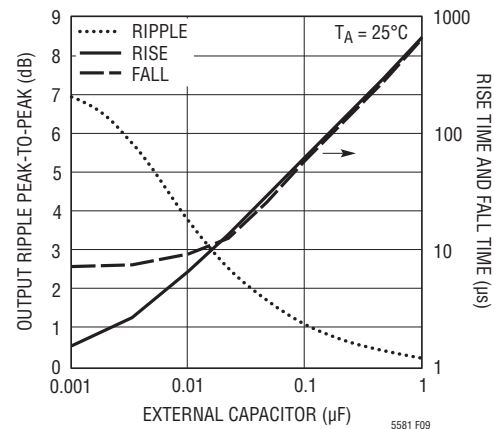

Figure 9. Residual Ripple, Output Transient Times for RF Pulse with WCDMA 4-Carrier Modulation vs External Filter Capacitor C₄

APPLICATIONS INFORMATION

Figure 10 shows that rise time and fall time are strong functions of RF input power. Data is taken without the output filter capacitor.

For a given RF modulation type—WCDMA, for example—the internal 150kHz filter provides nominal filtering of the residual ripple level. Additional external filtering occurs in the log domain, which introduces a systematic log error in relation to the signal’s crest factor, as shown in the following equation in dB.¹

$$\text{Error[dB]} = 10 \cdot \log_{10}(r + (1 - r)10^{-CF/10}) - CF \cdot (r-1)$$

Where CF is the crest factor and r is the duty cycle of the measurement (or number of measurements made at the

peak envelope, divided by the total number of periodic measurements in the measurement period). It is important to note that the CF refers to the 150kHz low pass filtered envelope of the signal. The error will depend on the statistics and bandwidth of the modulation signal in relation to the internal 150kHz filter. For example, in the case of WCDMA, simulations prove that it is possible to set the external filter capacitor corner frequency at 15kHz and only introduce an error less than 0.1dB.

Figure 11 depicts the output AM modulation ripple as a function of modulation difference frequency for a 2-tone input signal at 2140MHz with -10dBm input power. The

¹ Steve Murray, “Beware of Spectrum Analyzer Power Averaging Techniques,” *Microwaves & RF*, Dec. 2006.

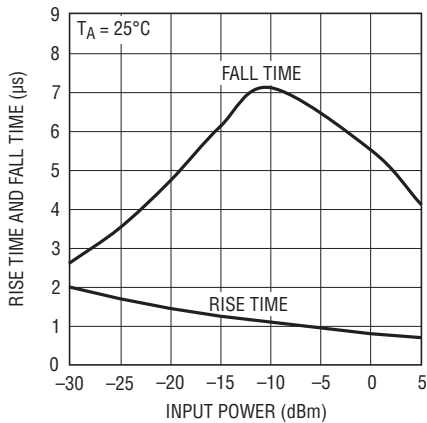

Figure 10. RF Pulse Response Rise Time and Fall Time vs RF Input Power

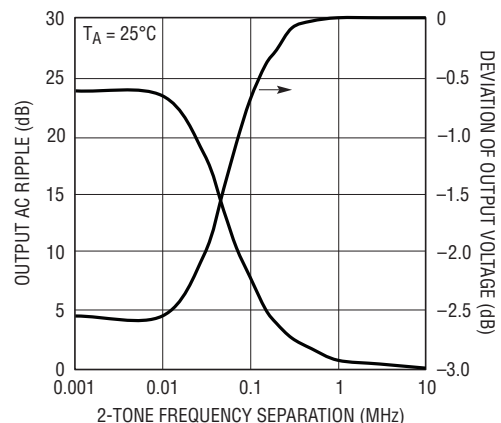

Figure 11. Output DC Voltage Deviation and Residual Ripple vs 2-Tone Separation Frequency

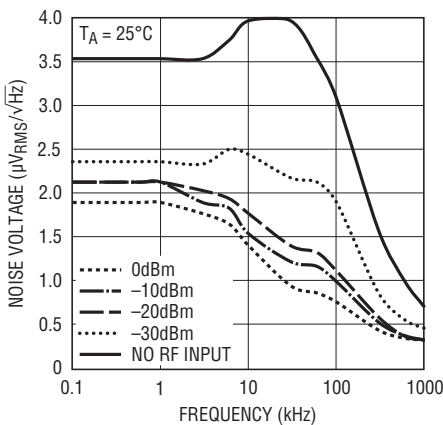

Figure 12. Output Voltage Noise Density

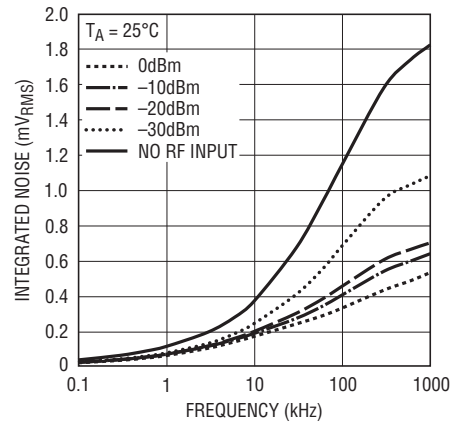

Figure 13. Integrated Output Voltage Noise

APPLICATIONS INFORMATION

resulting deviation in the output voltage of the detector shows the effect of the internal 150kHz filter.

The output voltage noise density and integrated noise are shown in Figures 12 and 13, respectively, for various input power levels. Noise is a strong function of input level. There is roughly a 10dB reduction in the output noise level for an input level of 0dBm versus no input.

Enable Pin

A simplified schematic of the EN pin is shown in Figure 14. To enable the LT5581, it is necessary to put greater than 1V on this pin. To disable or turn off the chip, this voltage should be below 0.3V. At an enable voltage of 3.3V, the pin draws roughly 20 μ A. If the EN pin is not connected, the chip is disabled through an internal 500k pull-down resistor.

It is important that the voltage applied to the EN pin never exceeds V_{CC} by more than 0.5V, otherwise, the supply current may be sourced through the upper ESD protection diode connected at the EN pin.

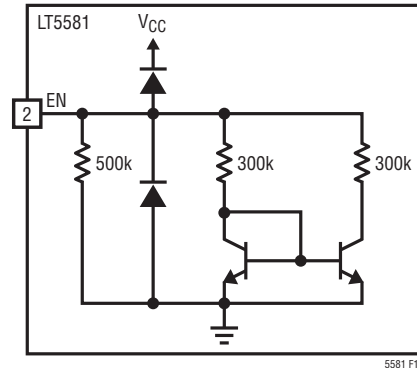
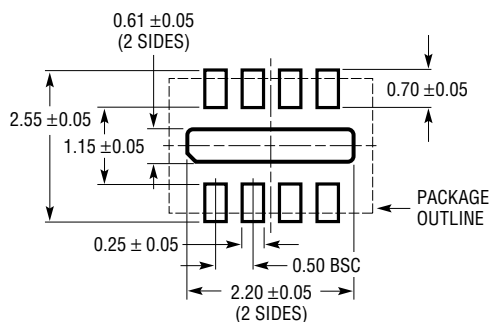

Figure 14. Enable Pin Simplified Schematic

PACKAGE DESCRIPTION

DDB Package 8-Lead Plastic DFN (3mm × 2mm) (Reference LTC DWG # 05-08-1702 Rev B)



RECOMMENDED SOLDER PAD PITCH AND DIMENSIONS

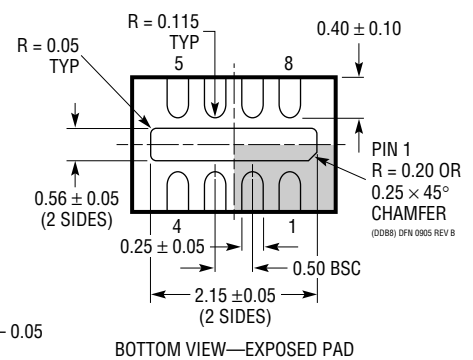
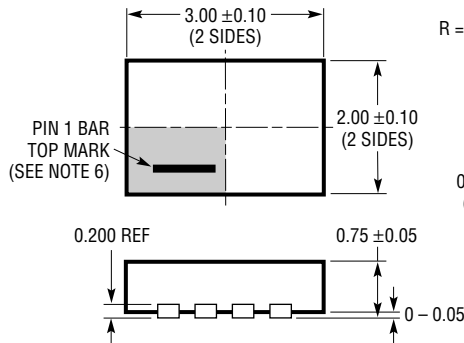

BOTTOM VIEW—EXPOSED PAD

NOTE:

1. DRAWING CONFORMS TO VERSION (WECD-1) IN JEDEC PACKAGE OUTLINE M0-229
2. DRAWING NOT TO SCALE
3. ALL DIMENSIONS ARE IN MILLIMETERS
4. DIMENSIONS OF EXPOSED PAD ON BOTTOM OF PACKAGE DO NOT INCLUDE MOLD FLASH. MOLD FLASH, IF PRESENT, SHALL NOT EXCEED 0.15mm ON ANY SIDE
5. EXPOSED PAD SHALL BE SOLDER PLATED
6. SHADED AREA IS ONLY A REFERENCE FOR PIN 1 LOCATION ON THE TOP AND BOTTOM OF PACKAGE

RELATED PARTS

PART NUMBER	DESCRIPTION	COMMENTS
RF Power Detectors		
LTC®5505	RF Power Detectors with >40dB Dynamic Range	300MHz to 3GHz, Temperature Compensated, 2.7V to 6V Supply
LTC5507	100kHz to 1000MHz RF Power Detector	100kHz to 1GHz, Temperature Compensated, 2.7V to 6V Supply
LTC5508	300MHz to 7GHz RF Power Detector	44dB Dynamic Range, Temperature Compensated, SC70 Package
LTC5509	300MHz to 3GHz RF Power Detector	36dB Dynamic Range, Low Power Consumption, SC70 Package
LTC5530	300MHz to 7GHz Precision RF Power Detector	Precision V _{OUT} Offset Control, Shutdown, Adjustable Gain
LTC5531	300MHz to 7GHz Precision RF Power Detector	Precision V _{OUT} Offset Control, Shutdown, Adjustable Offset
LTC5532	300MHz to 7GHz Precision RF Power Detector	Precision V _{OUT} Offset Control, Adjustable Gain and Offset
LT5534	50MHz to 3GHz Log RF Power Detector with 60dB Dynamic Range	±1dB Output Variation over Temperature, 38ns Response Time, Log Linear Response
LTC5536	Precision 600MHz to 7GHz RF Power Detector with Fast Comparator Output	25ns Response Time, Comparator Reference Input, Latch Enable Input, -26dBm to +12dBm Input Range
LT5537	Wide Dynamic Range Log RF/IF Detector	Low Frequency to 1GHz, 83dB Log Linear Dynamic Range
LT5538	75dB Dynamic Range 3.8GHz Log RF Power Detector	±0.8dB Accuracy Over Temperature
LT5570	60dB Dynamic Range RMS Detector	40MHz to 2.7GHz, ±0.5dB Accuracy Over Temperature
Infrastructure		
LT5514	Ultralow Distortion, IF Amplifier/ADC Driver with Digitally Controlled Gain	850MHz Bandwidth, 47dBm OIP3 at 100MHz, 10.5dB to 33dB Gain Control Range
LT5517	40MHz to 900MHz Quadrature Demodulator	21dBm IIP3, Integrated LO Quadrature Generator
LT5518	1.5GHz to 2.4GHz High Linearity Direct Quadrature Modulator	22.8dBm OIP3 at 2GHz, -158.2dBm/Hz Noise Floor, 50Ω Single-Ended RF and LO Ports, 4-Channel W-CDMA ACPR = -64dBc at 2.14GHz
LT5519	0.7GHz to 1.4GHz High Linearity Upconverting Mixer	17.1dBm IIP3 at 1GHz, Integrated RF Output Transformer with 50Ω Matching, Single-Ended LO and RF Ports Operation
LT5520	1.3GHz to 2.3GHz High Linearity Upconverting Mixer	15.9dBm IIP3 at 1.9GHz, Integrated RF Output Transformer with 50Ω Matching, Single-Ended LO and RF Ports Operation
LT5521	10MHz to 3700MHz High Linearity Upconverting Mixer	24.2dBm IIP3 at 1.95GHz, NF = 12.5dB, 3.15V to 5.25V Supply, Single-Ended LO Port Operation
LT5522	600MHz to 2.7GHz High Signal Level Downconverting Mixer	4.5V to 5.25V Supply, 25dBm IIP3 at 900MHz, NF = 12.5dB, 50Ω Single-Ended RF and LO Ports
LT5525	High Linearity, Low Power Downconverting Mixer	Single-Ended 50Ω RF and LO Ports, 17.6dBm IIP3 at 1900MHz, I _{CC} = 28mA
LT5526	High Linearity, Low Power Downconverting Mixer	3V to 5.3V Supply, 16.5dBm IIP3, 100kHz to 2GHz RF, NF = 11dB, I _{CC} = 28mA, -65dBm LO-RF Leakage
LT5527	400MHz to 3.7GHz High Signal Level Downconverting Mixer	IIP3 = 23.5dBm and NF = 12.5dBm at 1900MHz, 4.5V to 5.25V Supply, I _{CC} = 78mA, Conversion Gain = 2dB
LT5528	1.5GHz to 2.4GHz High Linearity Direct Quadrature Modulator	21.8dBm OIP3 at 2GHz, -159.3dBm/Hz Noise Floor, 50Ω, 0.5V _{DC} Baseband Interface, 4-Channel W-CDMA ACPR = -66dBc at 2.14GHz
LT5557	400MHz to 3.8GHz, 3.3V High Signal Level Downconverting Mixer	IIP3 = 23.7dBm at 2600MHz, 23.5dBm at 3600MHz, I _{CC} = 82mA at 3.3V
LT5560	Ultralow Power Active Mixer	10mA Supply Current, 10dBm IIP3, 10dB NF, Usable as Up- or Down-Converter.
LT5568	700MHz to 1050MHz High Linearity Direct Quadrature Modulator	22.9dBm OIP3 at 850MHz, -160.3dBm/Hz Noise Floor, 50Ω, 0.5V _{DC} Baseband Interface, 3-Ch CDMA2000 ACPR = -71.4dBc at 850MHz
LT5572	1.5GHz to 2.5GHz High Linearity Direct Quadrature Modulator	21.6dBm OIP3 at 2GHz, -158.6dBm/Hz Noise Floor, High-Ohmic 0.5V _{DC} Baseband Interface, 4-Ch W-CDMA ACPR = -67.7dBc at 2.14GHz
LT5575	800MHz to 2.7GHz High Linearity Direct Conversion I/Q Demodulator	50Ω, Single-Ended RF and LO Inputs. 28dBm IIP3 at 900MHz, 13.2dBm P1dB, 0.04dB I/Q Gain Mismatch, 0.4° I/Q Phase Mismatch